

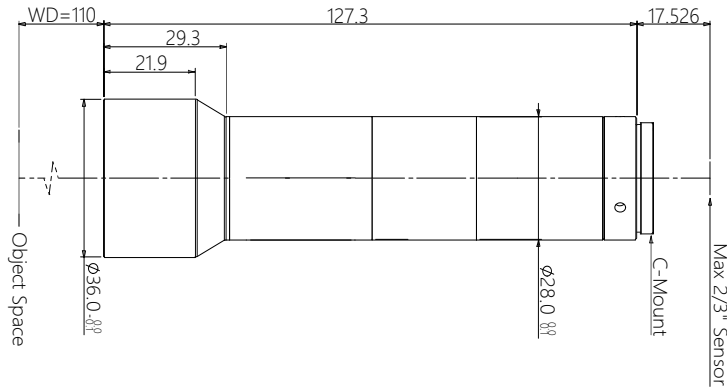

vision solution

# Specification

## SBS-YXDX110-0.5 Big Sensor Size Telecentric Lens



### Features (SBS-YXDX series)

- \* Large FOV with low magnification.
- \* Big working distance easy for illuminations and object allocation design.
- \* High accuracy, low distortion, high telecentricity.
- \* support up to 1.1" 12M class high-speed camera.

### Parameters

Mag.(x)	0.5
WD (mm)	110±2
Sensor size (Dia.mm)	11(2/3")
Image F#	7
Image MTF30(pl/mm)	>140
Object DOF (mm)	±1.1@F7
Object distortion (%)	<0.03
Object telecentric degree	<0.03

### Mechanical

Mount	C
Total length (mm)	127.3
Coaxial structure	N

### Field of View (mm x mm)

1/1.8" EV76C570 (7.2x5.4)	14.4x10.8
1/1.7" IMX226 (7.5x5.6)	15.0x11.2
2/3" IMX250/264 (8.45x7.1)	16.9x14.2