



vision solution

Specification

SBS-SCJ263-0.264

High Resolution Double Telecentric Lens

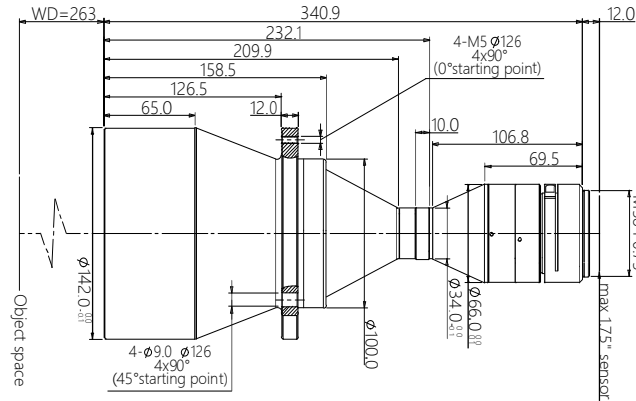

Features (SBS-SCJ series)

- * Excellent double telecentric design for high resolution image result.
- * Field of view is from 26mm to 300mm, suitable for most of application.
- * Big Iris, low distortion, high parallel degree, big depth of view.
- * Sensor size is available for 1/2.5" 1/2" 1/1.8" 2/3" 1" 4/3" 1.75" 2" φ39 35mm full.

Parameters

FOV (Dia.mm)	110
Mag.(x)	0.264
WD (mm)	263±4
Sensor size (Dia.mm)	29(1.75")
Image F#	6.8
Image MTF30(pl/mm)	>120
Object DOF (mm)	±9.2@F16
Object distortion (%)	<0.1
Object telecentric degree	<0.1
Object I/O(mm)	616±4

Mechanical

Mount	M42/M48/M58
Total length (mm)	340.9
N.W(KG)	3.2

Field of View (mm x mm)

1.75" CMV12000 (22.53x16.90)	85.3x64.0
1.75" PYTHON16k (18.43x18.43)	69.8x69.8
1.75" LineScan-4k (28.8mm)	109.1