

Specification

SBS-SCJ16K-330-0.311

16K High Resolution Telecentric Line Scan Lens

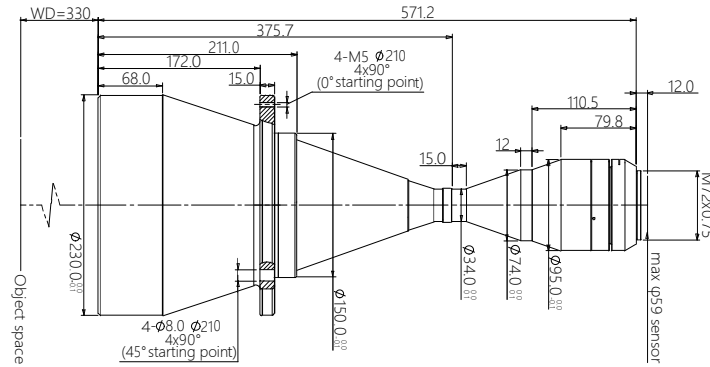

Features (SBS-SCJ16K series)

- High quality double telecentric design
- Designed specially for big large sensor
- Support 47M area scan or 16K line scan
- Mount and DOF can be changed as requested

Parameters

FOV (Dia. mm)	190
Mag.(x)	0.311
WD(mm)	330±5
Sensor size(Dia mm)	59
Image F#	8.7
Image MTF30(lp/mm)	>100
Object DOF(mm)	±6.6@F16
Image distortion(%)	<0.1
Object telecentric degree	<0.1
Object distance I/O(mm)	913±5

Mechanical

Mount	M72
Total length(mm)	571.2
N.W(KG)	11.1

FOV(mm x mm)

KAI-47051(48.7x29.0)	156.6x93.2
Linescan-16K(3.5/3.53um(57.4um)	184.6
Linescan-8K 7/7.04um(57.4mm)	184.6